

TS-XP-1510-80D

10Gb/s 80Km SFP+ ZR Optical Transceiver

PRODUCT FEATURES

- 1550nm cooled EML, APD Receiver
- Up to 80km on 9/125um SMF
- SFP+ MSA package with duplex LC connector
- SFI High Speed Electrical Interface
- Very low EMI and excellent ESD protection
- +3.3V single power supply
- Case temperature range: -5°C to 70°C.
- 2-wire interface for management and diagnostic monitor
- 10Gb/s serial optical interface compliant to 802.3ae 10GBASE-ZR/ZW
- Power dissipation < 1.5W

APPLICATIONS

- 10G Base-ZR/ZW
- 10G Fiber Channel
- 10G Storage system

STANDARD

- Compliant to SFF-8431 and SFF-8432
- Compliant with SFF-8472
- Compliant with IEEE 802.3ae 10GBASE-ZR and 10GBASE-ZW
- Compliant with IEC 60825-1 Class 1 laser eye safe
- RoHS Compliant

PRODUCT DESCRIPTION

TRANSCOM's SFP+ ZR transceivers is 1550nm cooled EML laser and APD photo-detector receiver based 10Gigabit SFP+ transceiver, which is designed to transmit and receive optical data over single mode optical fiber for link length up to 80km. Digital diagnostics functions are available via a 2-wire serial interface, as specified in the SFF-8472, which allows real-time access to device operating parameters such as transceiver temperature, laser bias current, transmitted optical power, received optical power and transceiver supply voltage.

I. Absolute Maximum Ratings

Parameter	Symbol	Min	Typ	Max	Unit	Ref.
Maximum Supply Voltage	Vcc3	-0.5		4.0	V	
Storage Temperature	Ts	-40		85	°C	
Operating Relative Humidity	RH			85	%	
Case Operating Temperature	Tcase	-5		70	°C	
Receiver Damage Threshold		6			dBm	

II. Electrical Characteristics (T_{case}= -5 to 70 °C, V_{CC3} = 3.13 to 3.47 Volts)

Parameter	Symbol	Min	Typ	Max	Unit	Ref.
Supply Voltage	Vcc3	3.13		3.47	V	
Supply Current	Icc			450	mA	
Module total power	P			1.5	W	1
Transmitter						
Input differential impedance	R _{in}		100		Ω	1
Differential data input swing	V _{in,pp}	300		1200	mV	
Transmit Disable Voltage	V _D	2.0		Vcc3	V	
Transmit Enable Voltage	V _{EN}	GND		GND+ 0.8	V	
Transmit Disable Assert Time				10	us	
Transmit Disable De-assert Time				2	ms	
Receiver						
Differential data output swing	V _{out-pp}	500	650	800	mV	2
Data output rise and fall time	Tr,Tf	30			ps	3
LOS Fault	V _{los-fault}	2		Vcc-host	V	4
LOS Normal	V _{los-nor}	GND		GND+0.8	V	4

Notes:

1. Connected directly to TX data input pins.
2. Input 100Ω differential termination.
3. These are unfiltered 20-80% values
4. LOS is an open collector output. Should be pulled-up with 4.7k Ω-10 k Ω on the host board. Normal operation is logic 0, loss of signal is 1

III. Optical Characteristics ($T_{\text{case}} = -5$ to 70 °C, $V_{\text{CC3}} = 3.13$ to 3.45 Volts)

Parameter	Symbol	Min	Typ	Max	Unit	Ref.
Transmitter						
Average Optical Power	P_{AVE}	0		5.0		1
Optical Wavelength	λ	1530	1550	1565	nm	
Side-Mode Suppression ratio	SMSR	30			dB	
Optical Extinction Ratio	ER	6.0			dB	
Transmitter and Dispersion Penalty	TDP			3.0	dB	
Average Launch power of OFF transmitter	P_{OFF}			-40	dBm	
Output Eye Mask	Compliant with IEEE 0802.3ae					
Relative Intensity Noise	RIN			-128	dB/Hz	
Receiver						
Receiver Sensitivity	R_{SENS}			-23.0	dBm	2
Input Saturation Power (Overload)	P_{sat}	-7			dBm	
Wavelength Range	λ_{C}	1260		1600	nm	
Receiver Reflectance	R_{rx}			-27	dB	
LOS De-Assert	LOS_{D}			-24	dBm	
LOS Assert	LOS_{A}	-32			dBm	
LOS Hysteresis		0.5		4.0	dB	

Notes:

1. Average power figures are informative only, per IEEE 802.3ae.
2. Measured with conformance test signal for BER = 10^{-12} .@10.3125Gbps, PRBS=2³¹-1,NRZ

IV. General Specifications

Parameter	Symbol	Min	Typ	Max	Units	Ref.
Bit Rate	BR		10.3125			1
Bit Error Ratio	BER			10 ⁻¹²		2
Maximum Supported Distances	Lmax		80		km	3

Notes:

- 10GBASE-ZR/ZW
- Tested with a 2³¹ – 1 PRBS
- SMF fiber, 1550nm wavelength

V. Pin Descriptions

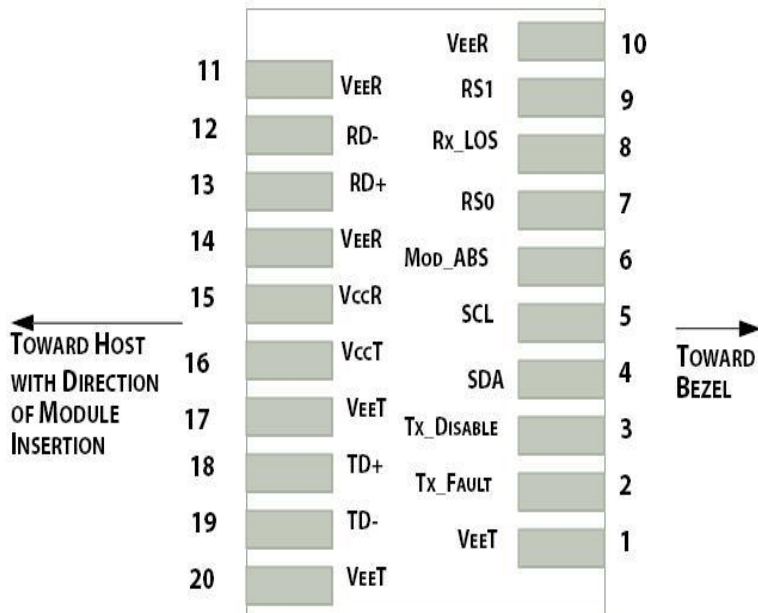

Diagram of Host Board Connector Block Pin Numbers and Name

Pin	Symbol	Name/Description	Ref
1	VEET	Transmitter Ground	1
2	Tx_FAULT	Transmitter fault	2
3	Tx_DISABLE	Transmitter Disable. Laser output disabled on high or open	3
4	SDA	2-wire Serial Interface Data Line	2
5	SCL	2-wire Serial Interface Clock Line	2
6	MOD_ABS	Module Absent. Grounded within the module	4

7	RS0	No connection required	
8	RX_LOS	Loss of Signal indication. Logic 0 indicates normal operation	2
9	RS1	No connection required	
10	VEER	Receiver Ground	1
11	VEER	Receiver Ground	1
12	RD-	Receiver Inverted DATA out. AC Coupled	
13	RD+	Receiver DATA out. AC Coupled	
14	VEER	Receiver Ground	1
15	VCCR	Receiver Power Supply	
16	VcCT	Transmitter Power Supply	
17	VEET	Transmitter Ground	1
18	TD+	Transmitter DATA in. AC Coupled	
19	TD-	Transmitter Inverted DATA in. AC Coupled	
20	VEET	Transmitter Ground	1

Notes:

1. Module circuit ground is isolated from module chassis ground within the module.
2. Should be pulled up with 4.7k – 10k ohms on host board to a voltage between 3.13V and 3.6V.
3. Tx_Disable is an input contact with a 4.7 kΩ to 10 kΩ pull-up to VccT inside the module
4. Mod_ABS is connected to VeeT or VeeR in the SFP+ module. The host may pull this contact up to Vcc_Host with a resistor in the range 4.7 kΩ to 10 kΩ. Mod_ABS is asserted “High” when the SFP+ module is physically absent from a host slot.

VI. Digital Diagnostic Functions

As defined by the SFP MSA, TRANSCOM’s SFP+ transceivers provide digital diagnostic functions via a 2-wire serial interface, which allows real-time access to the following operating parameters:

- Transceiver temperature
- Laser bias current
- Transmitted optical power
- Received optical power
- Transceiver supply voltage

It also provides a sophisticated system of alarm and warning flags, which may be used to alert end-users when

particular operating parameters are outside of a factory-set normal range.

The SFP MSA defines a 256-byte memory map in EEPROM that is accessible over a 2-wire serial interface at the 8 bit address 1010000X (A0h). The digital diagnostic monitoring interface makes use of the 8 bit address 1010001X (A2h), so the originally defined serial ID memory map remains unchanged.

The operating and diagnostics information is monitored and reported by a Digital Diagnostics Transceiver Controller (DDTC) inside the transceiver, which is accessed through a 2-wire serial interface. The memories are organized as a series of 8-bit data words that can be addressed individually or sequentially.

VII. Host - Transceiver Interface Block Diagram

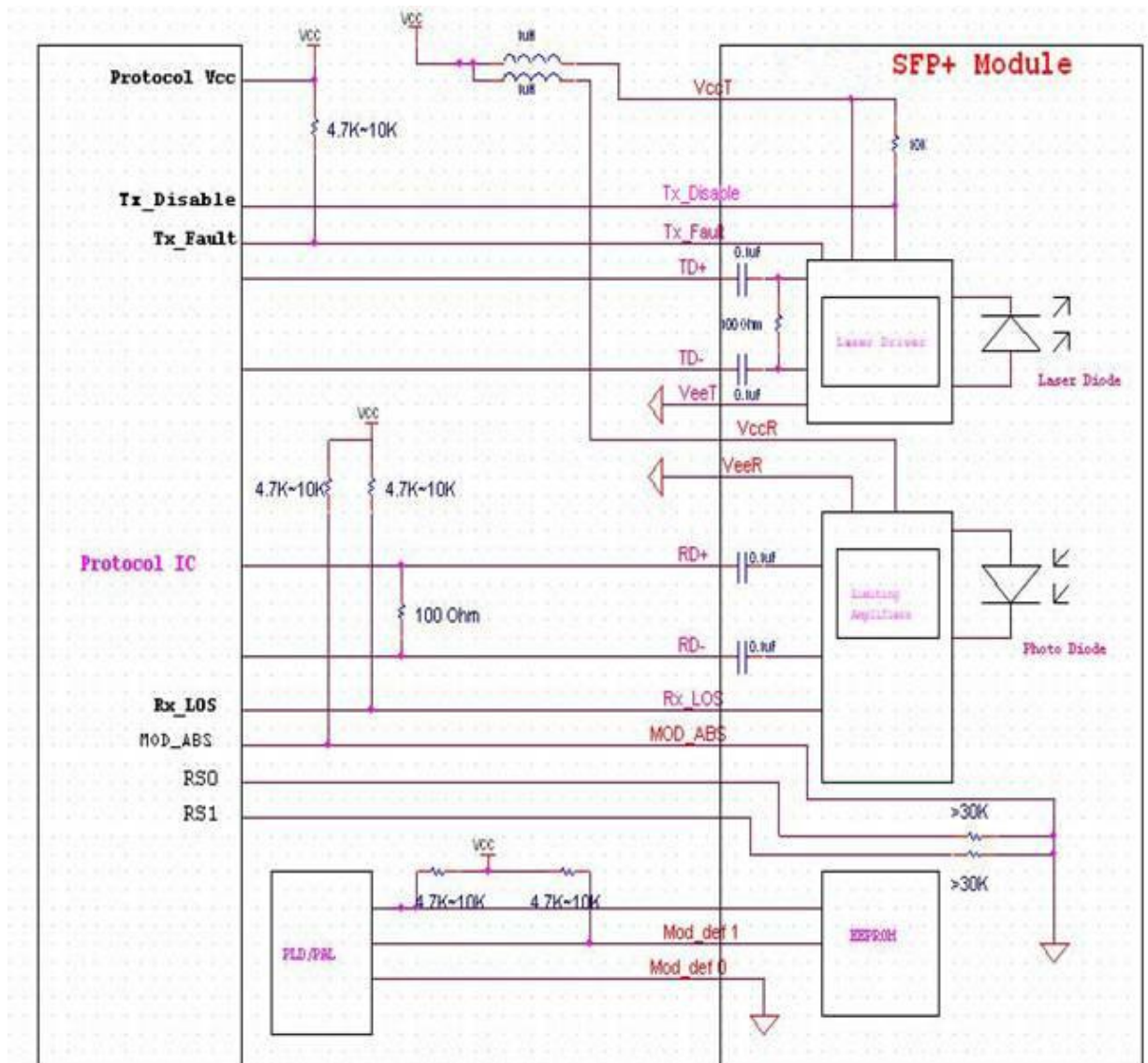

VIII. Outline Dimensions

TRANSCOM's SFP+ transceivers are compliant with the dimensions defined by the SFP Multi-Sourcing Agreement (MSA).

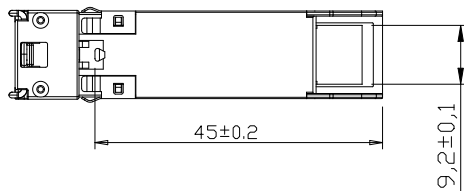
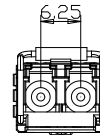
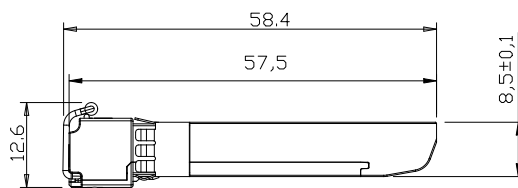
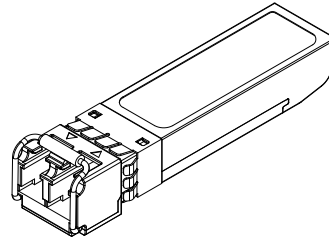
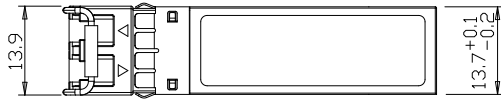

Units in mm

Appendix A. Document Revision

Version No.	Date	Description
1.0	2011-08-01	Preliminary datasheet
2.0	2011-11-10	Insert the "Case operation temperature" in page 2 and update "The Host - Transceiver Interface Block Diagram" in page 7