

TS-XP-1510-40D

10Gb/s 1550nm Single-mode SFP+ Transceiver

PRODUCT FEATURES

- Hot-pluggable SFP+ footprint
- Supports 9.5 to 10.3Gb/s bit rates
- Single 3.3V power supply
- Maximum link length of 40km
- 1550nm EML transmitter, PIN photo-detector
- Duplex LC connector
- Power dissipation < 1.5W
- Built-in digital diagnostic functions
- Case temperature range : -5°C to 70°C



APPLICATIONS

- 10GBASE-ER/EW 10G Ethernet

STANDARD

- Compliant with SFF-8472 SFP+ MSA.
- Compliant to SFP+ SFF-8431 and SFF-8432.
- Compliant to 802.3ae 10GBASE-ER.
- RoHS Compliant.

PRODUCT DESCRIPTION

TRANSCOM's SFP+ transceiver TS-XP-1510-40D is designed for use in 10-Gigabit Ethernet links up to 40km over single mode fiber. The module consists of 1550 EML Laser, InGaAs PIN and Preamplifier in a high-integrated optical sub-assembly. Digital diagnostics functions are available via a 2-wire serial interface, as specified in SFF8472. The module data link up to 40km in 9/125um single mode fiber.

I. Absolute Maximum Ratings

Parameter	Symbol	Min.	Typ.	Max.	Unit	Note
Storage Temperature	Ts	-40		85	°C	
Storage Ambient Humidity	HA	5		85	%	
Power Supply Voltage	VCC	-0.5		4	V	
Signal Input Voltage		-0.3		Vcc+0.3	V	
Receiver Damage Threshold		+4			dBm	

II. Recommended Operating Conditions

Parameter	Symbol	Min.	Typ.	Max.	Unit	Note
Operating Case Temperature	Tcase	-5		70	°C	Note (1)
Ambient Humidity	HA	5		85	%	
Power Supply Voltage	VCC	3.14	3.3	3.46	V	
Power Supply Current	ICC			450	mA	
Power Supply Noise Rejection				100	mVp-p	100Hz to 1MHz
Transmission Distance				40	km	
Coupled fiber	Single mode fiber					ITU-T G.653

Note: -10 to 60degC with 1.5m/s airflow

III. Optical Characteristics

Parameter	Symbol	Min.	Typ.	Max.	Unit	Note
Transmitter						
Average Launched Power	PO	-1		+4	dBm	Note (1)
Extinction Ratio	ER	6			dB	
Center Wavelength	λ_c	1530	1550	1565	nm	
Spectrum Band Width (RMS)	σ			1.0	nm	
SMSR		30			dB	
Transmitter OFF Output Power	POff			-40	dBm	
Optical Rise/Fall Time	tr/tf		100	260	ps	Note (2)
Transmitter and Dispersion Penalty	TDP			3.0	dB	
Output Eye Mask	Compliant with IEEE 0802.3ae					
Receiver						
Input Optical Wavelength	λ	1270		1610	nm	
Receiver Sensitivity				-15.8	dBm	Note (3)
Input Saturation Power (Overload)	Psat	0.5			dBm	
LOS Detect -Assert Power	PA	-28			dBm	
LOS Detect - Deassert Power	PD			-19	dBm	
LOS Detect Hysteresis	PHYS	0.5			dB	

Note:

1. Launched power (avg.) is power coupled into a single mode fiber with master connector. (Before of Life)
2. These are unfiltered 20-80% values.
3. Measured with conformance test signal for BER = 10^{-12} .@10.3125Gbps, PRBS=2³¹-1,NRZ

IV. Electrical Interface Characteristics

Parameter	Symbol	Min.	Typ.	Max.	Unit	Note
Transmitter						
Differential line input Impedance	RIN		100		Ohm	
Differential Data Input Swing	VDT	300		700	mVp-p	
Transmit Disable Voltage	Vdis	2		Vcc	V	LVTTL
Transmit Enable Voltage	Ven	Vee		Vee+0.8	V	
Receiver						
Differential Data Output Swing	VDR	400		850	mVp-p	Note (1)
LOS Output Voltage-High	VLOSH	Vee		Vee+0.8	V	LVTTL
LOS Output Voltage-Low	VLOSL	2		VccHOST	V	

Note: Into 100Ω differential termination.

V. Pin Description

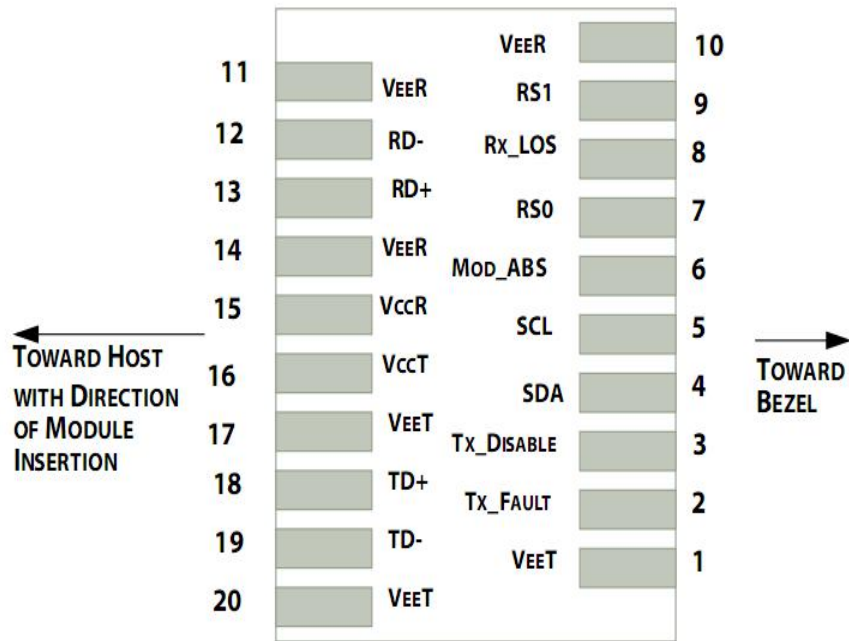

Pin out of Connector Block on Host Board

Pin	Symbol	Name/Description	Ref.
1	V _{EET}	Transmitter Ground (Common with Receiver Ground)	1
2	T _{FAULT}	Transmitter Fault.	2

3	T_{DIS}	Transmitter Disable. Laser output disabled on high or open.	3
4	SDA	2-wire Serial Interface Data Line	4
5	SCL	2-wire Serial Interface Clock Line	4
6	MOD_ABS	Module Absent. Grounded within the module	4
7	RS0	Rate Select 0	5
8	LOS	Loss of Signal indication. Logic 0 indicates normal operation.	6
9	RS1	No connection required	1
10	V_{EER}	Receiver Ground (Common with Transmitter Ground)	1
11	V_{EER}	Receiver Ground (Common with Transmitter Ground)	1
12	RD-	Receiver Inverted DATA out. AC Coupled	
13	RD+	Receiver Non-inverted DATA out. AC Coupled	
14	V_{EER}	Receiver Ground (Common with Transmitter Ground)	1
15	V_{CCR}	Receiver Power Supply	
16	V_{CCT}	Transmitter Power Supply	
17	V_{EET}	Transmitter Ground (Common with Receiver Ground)	1
18	TD+	Transmitter Non-Inverted DATA in. AC Coupled.	
19	TD-	Transmitter Inverted DATA in. AC Coupled.	
20	V_{EET}	Transmitter Ground (Common with Receiver Ground)	1

Notes:

1. Circuit ground is internally isolated from chassis ground.
2. T_{FAULT} is an open collector/drain output, which should be pulled up with a 4.7k – 10k Ohms resistor on the host board if intended for use. Pull up voltage should be between 2.0V to $V_{cc} + 0.3V$. A high output indicates a transmitter fault caused by either the TX bias current or the TX output power exceeding the preset alarm thresholds. A low output indicates normal operation. In the low state, the output is pulled to <0.8V.
3. Laser output disabled on $T_{DIS} > 2.0V$ or open, enabled on $T_{DIS} < 0.8V$.
4. Should be pulled up with 4.7k Ω - 10k Ω host board to a voltage between 2.0V and 3.6V. MOD_ABS pulls line low to indicate module is plugged in.
5. Internally pulled down per SFF-8431 Rev 4.1.
6. LOS is open collector output. It should be pulled up with 4.7k Ω – 10k Ω on host board to a voltage between 2.0V and 3.6V. Logic 0 indicates normal operation; logic 1 indicates loss of signal.

VI. Recommended Interface Circuit

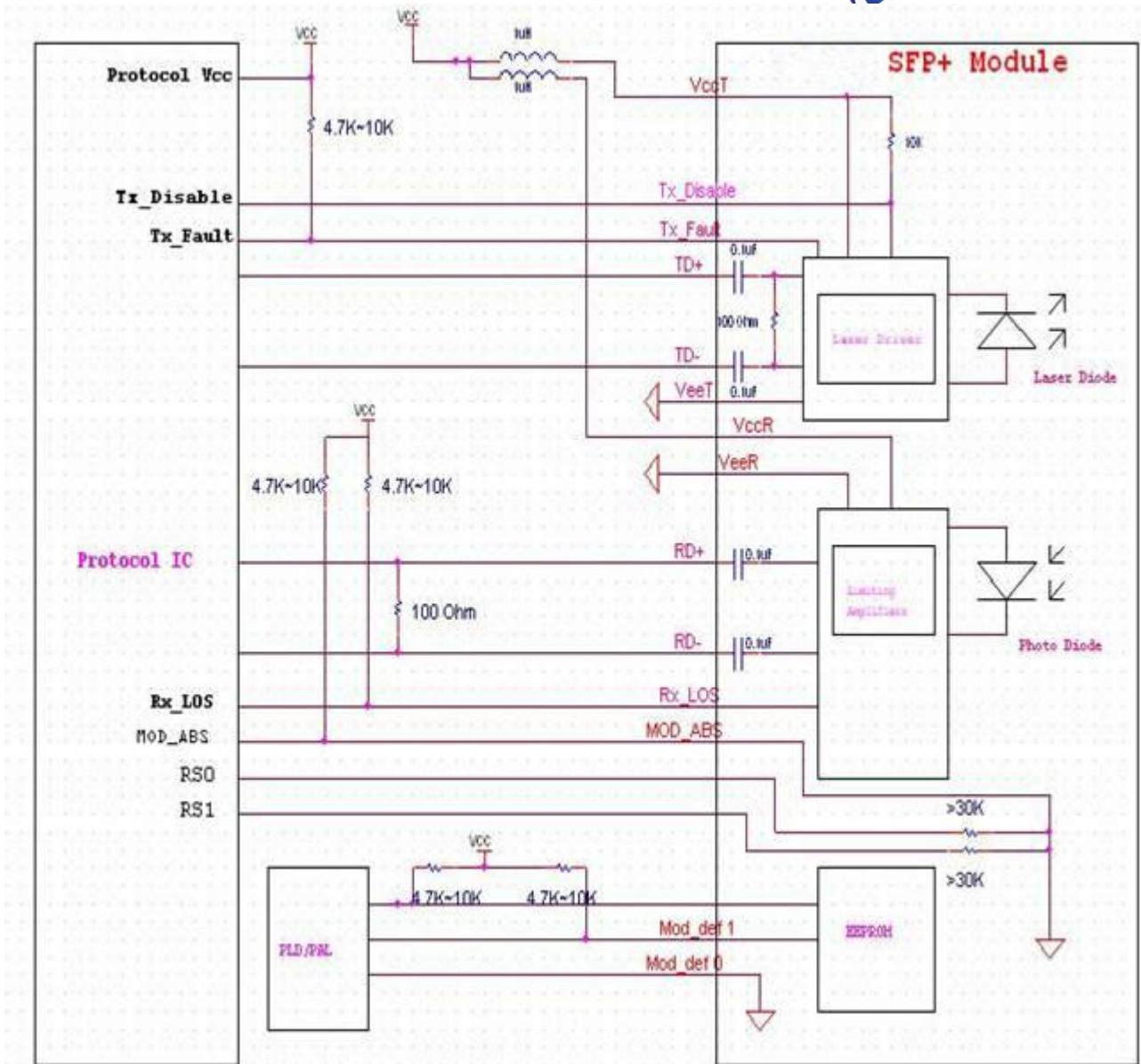

VII. Outline Dimensions

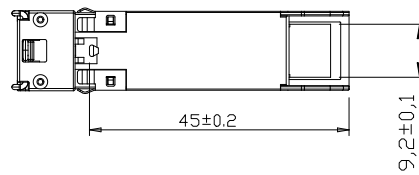
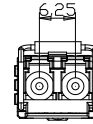
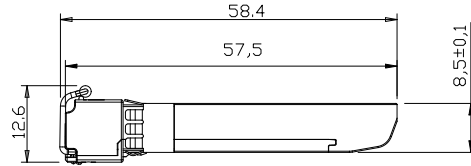
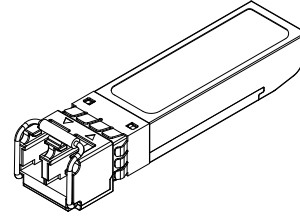
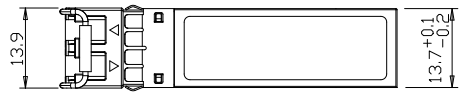

Units in mm

VIII. Regulatory Compliance

Feature	Reference	Performance
Electrostatic discharge (ESD)	IEC/EN 61000-4-2	Compatible with standards
Electromagnetic Interference (EMI)	FCC Part 15 Class B EN 55022 Class B (CISPR 22A)	Compatible with standards
Laser Eye Safety	FDA 21CFR 1040.10, 1040.11 IEC/EN 60825-1, 2	Class 1 laser product
Component Recognition	IEC/EN 60950, UL	Compatible with standards
ROHS	2002/95/EC	Compatible with standards
EMC	EN61000-3	Compatible with standards

Appendix A. Document Revision

Version No.	Date	Description
1.0	2010-09-01	Preliminary datasheet
2.0	2011-09-10	Update format and company's logo