

TS-SF-BL45(54)12-F0D

SFP BIDI DDM 1.25G 1490/1550nm(1550/1490nm) 160KM Transceiver

PRODUCT FEATURES

- Up to 1.25Gb/s data links with DDM
- DFB laser transmitter
- APD receiver
- Up to 160km on 9/125µm SMF
- Hot-pluggable SFP footprint
- BIDI LC/UPC type pluggable optical interface
- Low power dissipation
- Metal enclosure, for lower EMI
- RoHS compliant and lead-free
- Single +3.3V power supply
- Compliant with SFF-8472
- Case operating temperature: 0°C to +70°C

APPLICATIONS

- Switch to Switch Interface
- Gigabit Ethernet
- Switched Backplane Applications
- Router/Server Interface
- Other Optical Links

PRODUCT DESCRIPTION

TRANSCOM's TS-SF-BL45(54)12-F0D Small Form Factor Pluggable (SFP) transceivers are compatible with the Small Form Factor Pluggable Multi-Sourcing Agreement (MSA), The transceiver consists of five sections: the LD driver, the limiting amplifier, the digital diagnostic monitor, the DFB laser and the APD receiver. The module data link up to 160KM in 9/125um single mode fiber.

The optical output can be disabled by a TTL logic high-level input of Tx Disable, and the system also can disable the module via I2C. Tx Fault is provided to indicate that degradation of the laser. Loss of signal (LOS) output is provided to indicate the loss of an input optical signal of receiver or the link status with partner. The system can also get the LOS (or

Link)/Disable/Fault information via I2C register access.

I. Pin Descriptions

Pin	Symbol	Name/Description	Ref.
1	V _{EET}	Transmitter Ground (Common with Receiver Ground)	1
2	T _{FAULT}	Transmitter Fault.	
3	T _{DIS}	Transmitter Disable. Laser output disabled on high or open.	2
4	MOD_DEF(2)	Module Definition 2. Data line for Serial ID.	3
5	MOD_DEF(1)	Module Definition 1. Clock line for Serial ID.	3
6	MOD_DEF(0)	Module Definition 0. Grounded within the module.	3
7	Rate Select	No connection required	4
8	LOS	Loss of Signal indication. Logic 0 indicates normal operation.	5
9	V _{EER}	Receiver Ground (Common with Transmitter Ground)	1
10	V _{EER}	Receiver Ground (Common with Transmitter Ground)	1
11	V _{EER}	Receiver Ground (Common with Transmitter Ground)	1
12	RD-	Receiver Inverted DATA out. AC Coupled	
13	RD+	Receiver Non-inverted DATA out. AC Coupled	
14	V _{EER}	Receiver Ground (Common with Transmitter Ground)	1
15	V _{CCR}	Receiver Power Supply	
16	V _{CCT}	Transmitter Power Supply	
17	V _{EET}	Transmitter Ground (Common with Receiver Ground)	1
18	TD+	Transmitter Non-Inverted DATA in. AC Coupled.	
19	TD-	Transmitter Inverted DATA in. AC Coupled.	
20	V _{EET}	Transmitter Ground (Common with Receiver Ground)	1

Notes:

1. Circuit ground is internally isolated from chassis ground.
2. Laser output disabled on T_{DIS} >2.0V or open, enabled on T_{DIS} <0.8V.
3. Should be pulled up with 4.7k - 10kohms on host board to a voltage between 2.0V and 3.6V. MOD_DEF(0) pulls line low to indicate module is plugged in.
4. This is an optional input used to control the receiver bandwidth for compatibility with multiple data rates (most likely Fiber Channel 1x and 2x Rates). If implemented, the input will be internally pulled down with > 30kΩ resistor. The input states are:
 - Low (0 – 0.8V): Reduced Bandwidth
 - (> 0.8V, < 2.0V): Undefined
 - High (2.0 – 3.465V): Full Bandwidth
 - Open: Reduced Bandwidth
5. LOS is open collector output should be pulled up with 4.7k - 10kohms on host board to a voltage between 2.0V and 3.6V. Logic 0 indicates normal operation; logic 1 indicates loss of signal.

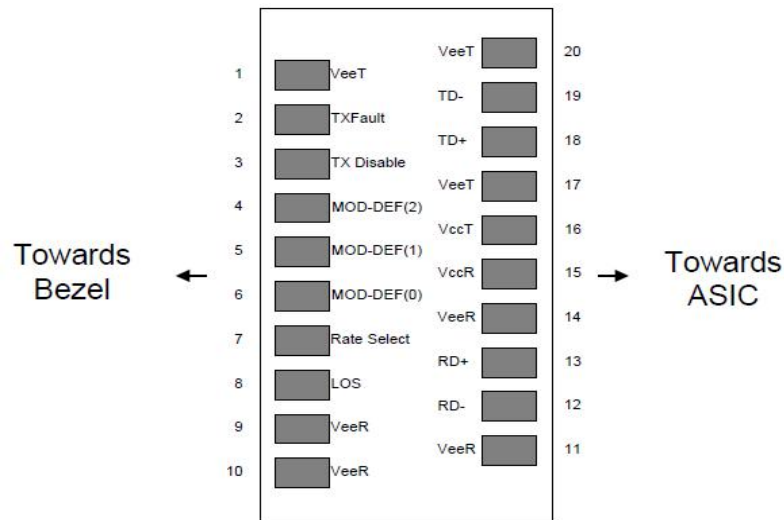

Figure 2: Pin-out of Connector Block on Host Board

II. Absolute Maximum Ratings

Parameter	Symbol	Min.	Typ.	Max.	Unit	Note
Storage Temperature	Ts	-40		85	°C	
Storage Ambient Humidity	HA	5		95	%	
Power Supply Voltage	VCC	-0.5		4	V	
Signal Input Voltage		-0.3		Vcc+0.3	V	
Receiver Damage Threshold		5			dBm	

III. Recommended Operating Conditions

Parameter	Symbol	Min.	Typ.	Max.	Unit	Note	
Case Operating Temperature	Tcase	0		70	°C		
Ambient Humidity	HA	5		70	%	Non-condensing	
Power Supply Voltage	VCC	3.13	3.3	3.47	V		
Power Supply Current	ICC			300	mA		
Power Supply Noise Rejection				100	mVp-p	100Hz to 1MHz	
Data Rate			1.25/1.25		Gbps	TX Rate/RX Rate	
Transmission Distance				160	KM		
Coupled Fiber		Single mode fiber					9/125um SMF

IV. Specification of Transmitter

Parameter	Symbol	Min.	Typ.	Max.	Unit	Note
Average Output Power	P _{OUT}	2		6	dBm	
Extinction Ratio	ER	9			dB	
Center Wavelength	λ_c	1470	1490	1510	nm	TS-SF-BL4512-F0D
		1530	1550	1570		TS-SF-BL5412-F0D
Side Mode Suppression Ratio	SMSR	30			dB	DFB Laser
Spectrum Bandwidth(-20dB)	σ			1	nm	
Transmitter OFF Output Power	P _{OFF}			-45	dBm	
Differential Line Input Impedance	R _{IN}	90	100	110	Ohm	
Jitter P-P	t _j			128	ps	Note (1)
Output Eye Mask	Compliant with IEEE802.3 z (class 1 laser safety)					Note (2)

Note (1): Measure at 2⁷-1 NRZ PRBS pattern

Note (2): Transmitter eye mask definition

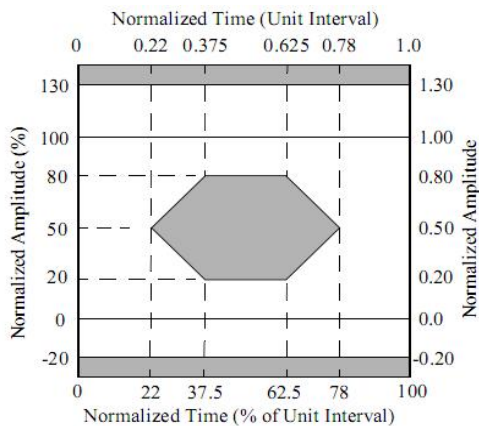

V. Specification of Receiver

Parameter	Symbol	Min.	Typ.	Max.	Unit	Note
Input Optical Wavelength	λ_{IN}	1530	1550	1570	nm	TS-SF-BL5412-F0D
		1470	1490	1510		TS-SF-BL4512-F0D
Receiver Sensitivity	P _{IN}			-34	dBm	Note (1)
Input Saturation Power (Overload)	P _{SAT}	-10			dBm	
Los Of Signal Assert	P _A	-40			dBm	
Los Of Signal De-assert	P _D			-35	dBm	Note (2)
LOS Hysteresis	P _A -P _D	0.5	2	6	dB	

Note (1): Measured with Light source 1550nm(1490nm), ER=9dB; BER = $\leq 10^{-12}$ @PRBS=2⁷-1 NRZ

Note (2): When LOS de-asserted, the RX data+/- output is High-level (fixed)

VI. Electrical Interface Characteristics

Parameter	Symbol	Min.	Typ.	Max.	Unit	Note
Transmitter						
Total Supply Current	I _{CC}			A	mA	Note (1)
Transmitter Disable Input-High	V _{DISH}	2		V _{CC} +0.3	V	
Transmitter Disable Input-Low	V _{DISL}	0		0.8	V	
Transmitter Fault Input-High	V _{DISL}	2		V _{CC} +0.3	V	
Transmitter Fault Input-Low	V _{TxFH}	0		0.8	V	
Receiver						
Total Supply Current	I _{CC}			B	mA	Note (1)
LOSS Output Voltage-High	V _{LOSH}	2		V _{CC} +0.3	V	LVTTL
LOSS Output Voltage-Low	V _{LOSL}	0		0.8	V	

Note (1): A (TX) + B (RX) = 300mA (Not include termination circuit)

VII. Digital Diagnostic Functions

TRANSCOM's TS-SF-BL45(54)12-F0D transceivers support the 2-wire serial communication protocol as defined in the SFP MSA. It is very closely related to the E2PROM defined in the GBIC standard, with the same electrical specifications.

The standard SFP serial ID provides access to identification information that describes the transceiver's capabilities, standard interfaces, manufacturer, and other information.

Additionally, TRANSCOM SFP transceivers provide a unique enhanced digital diagnostic monitoring interface, which allows real-time access to device operating parameters such as transceiver temperature, laser bias current, transmitted optical power, received optical power and transceiver supply voltage. It also defines a sophisticated system of alarm and warning flags, which alerts end-users when particular operating parameters are outside of a factory set normal range.

The SFP MSA defines a 256-byte memory map in E2PROM that is accessible over a 2-wire serial interface at the 8 bit address 1010000X (A0h). The digital diagnostic monitoring interface makes use of the 8 bit address 1010001X (A2h), so the originally defined serial ID memory map remains unchanged. The interface is identical to, and is thus fully backward compatible with both the GBIC Specification and the SFP Multi Source Agreement.

The operating and diagnostics information is monitored and reported by a Digital Diagnostics. Transceiver Controller (DDTC) inside the transceiver, which is accessed through a 2-wire serial interface. When the serial protocol is activated, the serial clock signal (SCL, Mod Def 1) is generated by the host. The positive edge clocks data into the SFP transceiver into those segments of the E2PROM that are not write-protected. The negative edge clocks data from the SFP transceiver. The serial data signal (SDA, Mod Def 2) is bi-directional for serial data transfer. The host uses SDA in conjunction with SCL to mark the start and end of serial protocol activation. The memories are organized as a series of 8-bit data words that can be addressed individually or sequentially.

Digital diagnostics for the TS-SF-BL45(54)12-F0D are Internally calibrated by default.

VIII. Recommend Circuit Schematic

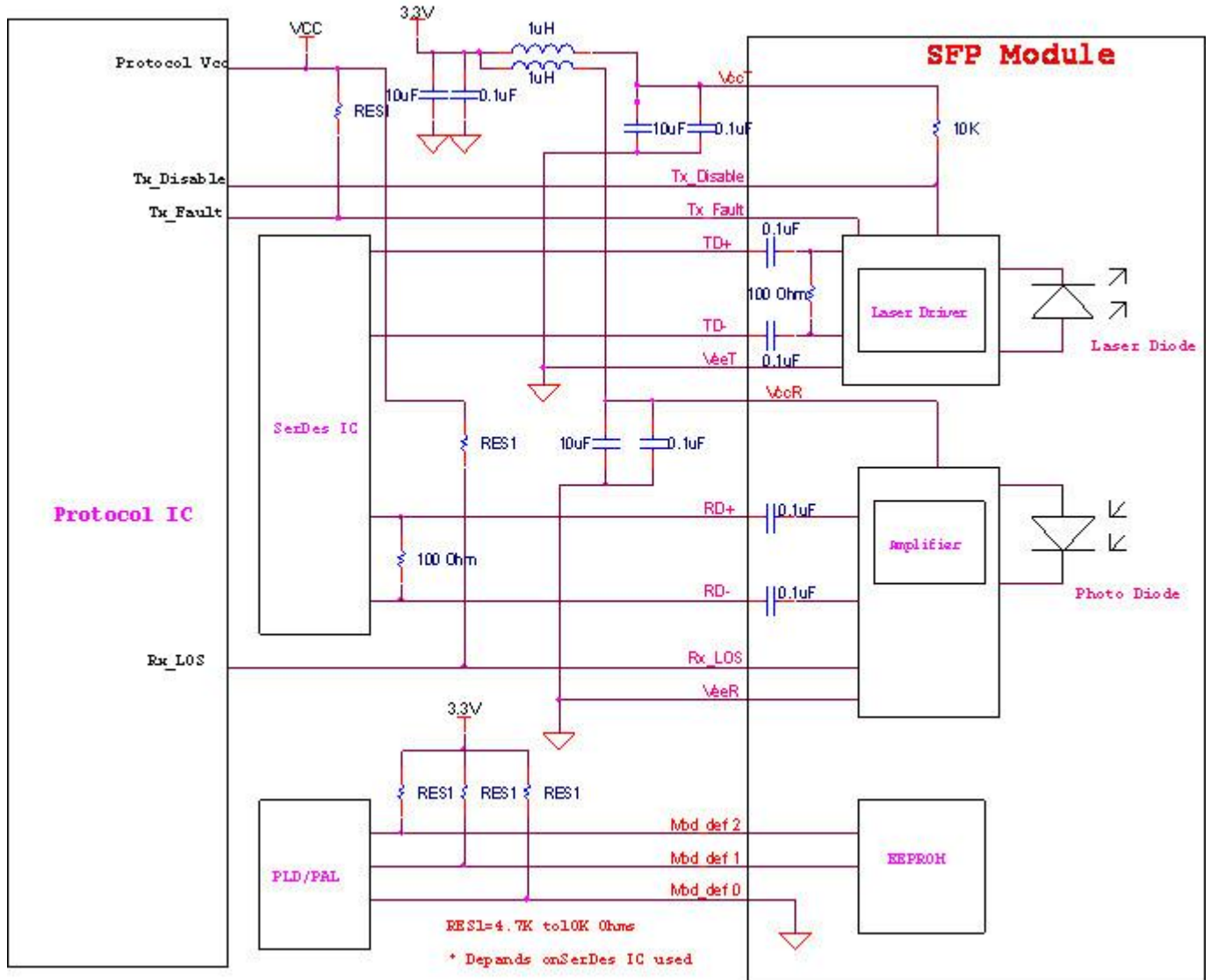

IX. Mechanical Specifications (Unit: mm)

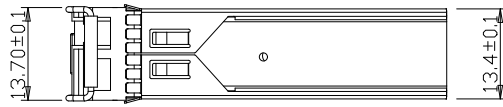

Units in mm

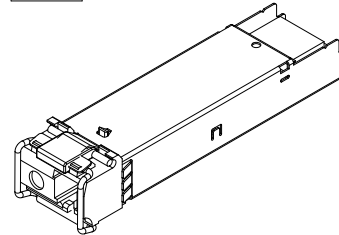
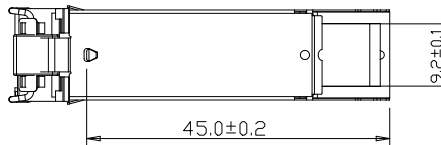
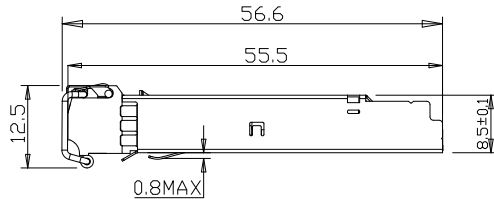

TS-SF-BL45(54)12-F0D

X. Regulatory Compliance

Feature	Reference	Performance
Electrostatic discharge (ESD)	IEC/EN 61000-4-2	Compatible with standards
Electromagnetic Interference (EMI)	FCC Part 15 Class B EN 55022 Class B (CISPR 22A)	Compatible with standards
Laser Eye Safety	FDA 21CFR 1040.10, 1040.11 IEC/EN 60825-1 , 2	Class 1 laser product
Component Recognition	IEC/EN 60950 , UL	Compatible with standards
ROHS	2002/95/EC	Compatible with standards
EMC	EN61000-3	Compatible with standards

Appendix A. Document Revision

Version No.	Date	Description
1.0	2010-09-01	Preliminary datasheet
2.0	2011-09-10	Update format and company's logo