

TS-SF-1315-02

155Mb/s 1310nm Single-mode SFP Transceiver

PRODUCT FEATURES

- Up to 155Mb/s data links
- FP laser transmitter and PIN photo-detector.
- Up to 2km on 9/125 μ m SMF
- Hot-pluggable SFP footprint
- Duplex LC/UPC type pluggable optical interface
- Low power dissipation
- Metal enclosure, for lower EMI
- RoHS compliant and lead-free
- Single +3.3V power supply
- Compliant with SFF-8472
- Case operating temperature

Commercial: 0°C to +70°C

Extended: -10°C to +80°C

Industrial: -40°C to +85°C



APPLICATIONS

- Switch to Switch Interface
- Fast Ethernet
- Switched Backplane Applications

- Router/Server Interface
- Other Optical Links

PRODUCT DESCRIPTION

TRANSCOM's TS-SF-1315-02 Small Form Factor Pluggable (SFP) transceivers are compatible with the Small Form Factor Pluggable Multi-Sourcing Agreement (MSA). The transceiver consists of four sections: the LD driver, the limiting amplifier, the 1310nm FP laser and the PIN photo-detector. The module data links up to 2KM in 9/125 um single mode fiber.

The optical output can be disabled by a TTL logic high-level input of Tx Disable, and the system also can disable the module via I2C. Tx Fault is provided to indicate that degradation of the laser. Loss of signal (LOS) output is provided to indicate the loss of an input optical signal of receiver or the link status with partner. The system can also get the LOS (or Link)/Disable/Fault information via I2C register access.

Ordering information

Product part Number	Data Rate (Mbps)	Media	Wavelength (nm)	Transmission Distance(km)	Temperature Range(Tcase) (°C)	
TS-SF-1315-02	155	Single mode fiber	1310	2	0~70	commercial
TS-SF-1315-02E	155	Single mode fiber	1310	2	-10~80	extended
TS-SF-1315-02A	155	Single mode fiber	1310	2	-40~85	industrial

I. Pin Descriptions

Pin	Symbol	Name/Description	Ref.
1	V _{EET}	Transmitter Ground (Common with Receiver Ground)	1
2	T _{FAULT}	Transmitter Fault.	
3	T _{DIS}	Transmitter Disable. Laser output disabled on high or open.	2
4	MOD_DEF(2)	Module Definition 2. Data line for Serial ID.	3
5	MOD_DEF(1)	Module Definition 1. Clock line for Serial ID.	3
6	MOD_DEF(0)	Module Definition 0. Grounded within the module.	3
7	Rate Select	No connection required	4
8	LOS	Loss of Signal indication. Logic 0 indicates normal operation.	5
9	V _{EER}	Receiver Ground (Common with Transmitter Ground)	1

10	V _{EER}	Receiver Ground (Common with Transmitter Ground)	1
11	V _{EER}	Receiver Ground (Common with Transmitter Ground)	1
12	RD-	Receiver Inverted DATA out. AC Coupled	
13	RD+	Receiver Non-inverted DATA out. AC Coupled	
14	V _{EER}	Receiver Ground (Common with Transmitter Ground)	1
15	V _{CCR}	Receiver Power Supply	
16	V _{CCT}	Transmitter Power Supply	
17	V _{EET}	Transmitter Ground (Common with Receiver Ground)	1
18	TD+	Transmitter Non-Inverted DATA in. AC Coupled.	
19	TD-	Transmitter Inverted DATA in. AC Coupled.	
20	V _{EET}	Transmitter Ground (Common with Receiver Ground)	1

Notes:

1. Circuit ground is internally isolated from chassis ground.
2. Laser output disabled on T_{DIS} >2.0V or open, enabled on T_{DIS} <0.8V.
3. Should be pulled up with 4.7k - 10kohms on host board to a voltage between 2.0V and 3.6V. MOD_DEF (0) pulls line low to indicate module is plugged in.
4. This is an optional input used to control the receiver bandwidth for compatibility with multiple data rates (most likely Fiber Channel 1x and 2x Rates). If implemented, the input will be internally pulled down with > 30kΩ resistor. The input states are:
 - Low (0 – 0.8V): Reduced Bandwidth
 - (>0.8, < 2.0V): Undefined
 - High (2.0 – 3.465V): Full Bandwidth
 - Open: Reduced Bandwidth
5. LOS is open collector output should be pulled up with 4.7k-10k ohms on host board to a voltage between 2.0V and 3.6V. Logic 0 indicates normal operation; logic 1 indicates loss of signal.

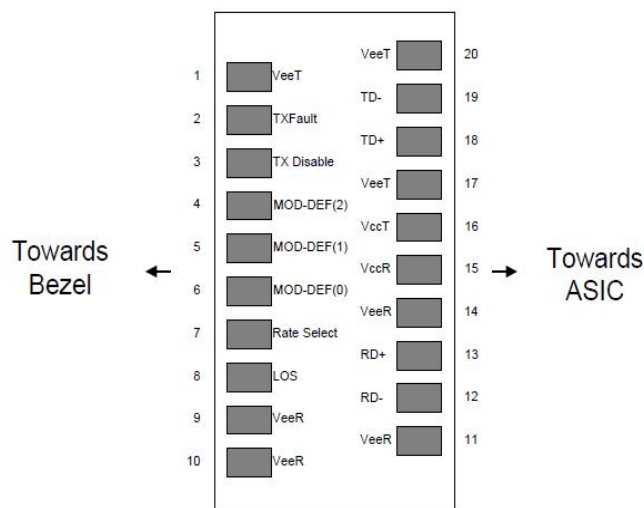

Figure2. Pin out of Connector Block on Host Board

II. Absolute Maximum Ratings

Parameter	Symbol	Min.	Typ.	Max.	Unit	Note
Storage Temperature	Ts	-40		85	°C	
Storage Ambient Humidity	HA	5		95	%	
Power Supply Voltage	VCC	-0.5		4	V	
Signal Input Voltage		-0.3		Vcc+0.3	V	
Receiver Damage Threshold		5			dBm	

III. Recommended Operating Conditions

Parameter	Symbol	Min.	Typ.	Max.	Unit	Note	
Case Operating Temperature	Tcase	0		70	°C	TS-SF-1315-02	
		-10		80		TS-SF-1315-02E	
		-40		85		TS-SF-1315-02A	
Ambient Humidity	HA	5		70	%	Non-condensing	
Power Supply Voltage	VCC	3.13	3.3	3.47	V		
Power Supply Current	ICC			280	mA		
Power Supply Noise Rejection				100	mVp-p	100Hz to 1MHz	
Data Rate			155/155		Mbps	TX Rate/RX Rate	
Transmission Distance				2	KM		
Coupled Fiber		Single mode fiber					9/125um SMF

IV. Specification of Transmitter

Parameter	Symbol	Min.	Typ.	Max.	Unit	Note
Average Output Power	P _{OUT}	-15		-8	dBm	
Extinction Ratio	ER	8.2			dB	
Center Wavelength	λ_c	1270	1310	1360	nm	FP Laser
Spectrum Width (RMS)	σ			3.5	nm	
Transmitter OFF Output Power	P _{off}			-45	dBm	
Differential Line Input Impedance	R _{IN}	90	100	110	Ohm	
Total Jitter (Peak-Peak)	t _j			1	ns	Note (1)
Output Eye Mask	Compliant with G.957(class 1 laser safety)					Note (2)

Note (1): Measured at 2²³-1 NRZ PRBS pattern.

(2): Transmitter eye mask definition.

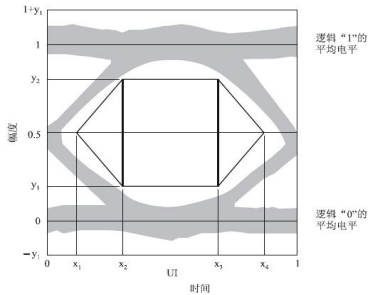

	STM-1	STM-4
x_1/x_4	0.15/0.85	0.25/0.75
x_2/x_3	0.35/0.65	0.40/0.60
y_1/y_2	0.20/0.80	0.20/0.80

V. Specification of Receiver

Parameter	Symbol	Min.	Typ.	Max.	Unit	Note
Input Optical Wavelength	λ_{IN}	1270		1610	nm	
Receiver Sensitivity	P _{IN}			-24	dBm	Note (1)
Input Saturation Power (Overload)	P _{SAT}	-8			dBm	
Los Of Signal Assert	P _A			-25	dBm	
Los Of Signal De-assert	P _D	-38			dBm	Note (2)
LOS Hysteresis	P _A -P _D	0.5	2	6	dB	

Note (1): Measured with Light source 1310nm, ER=8.2dB; BER = $\leq 10^{-12}$ @PRBS=2²³-1 NRZ.

Note (2): When LOS de-asserted, the RX data+/- output is High-level (fixed)

VI. Electrical Interface Characteristics

Parameter	Symbol	Min.	Typ.	Max.	Unit	Note
Transmitter						
Total Supply Current	I _{CC}			A	mA	Note (1)
Transmitter Disable Input-High	V _{DISH}	2		V _{CC} +0.3	V	
Transmitter Disable Input-Low	V _{DISL}	0		0.8	V	
Transmitter Fault Input-High	V _{DISL}	2		V _{CC} +0.3	V	
Transmitter Fault Input-Low	V _{TXFH}	0		0.8	V	
Receiver						
Total Supply Current	I _{CC}			B	mA	Note (1)
LOSS Output Voltage-High	V _{LOSH}	2		V _{CC} +0.3	V	LVTTTL
LOSS Output Voltage-Low	V _{LOSL}	0		0.8	V	

Note (1) A (TX) + B (RX) = 280mA (Not include termination circuit)

VII. Recommend Circuit Schematic

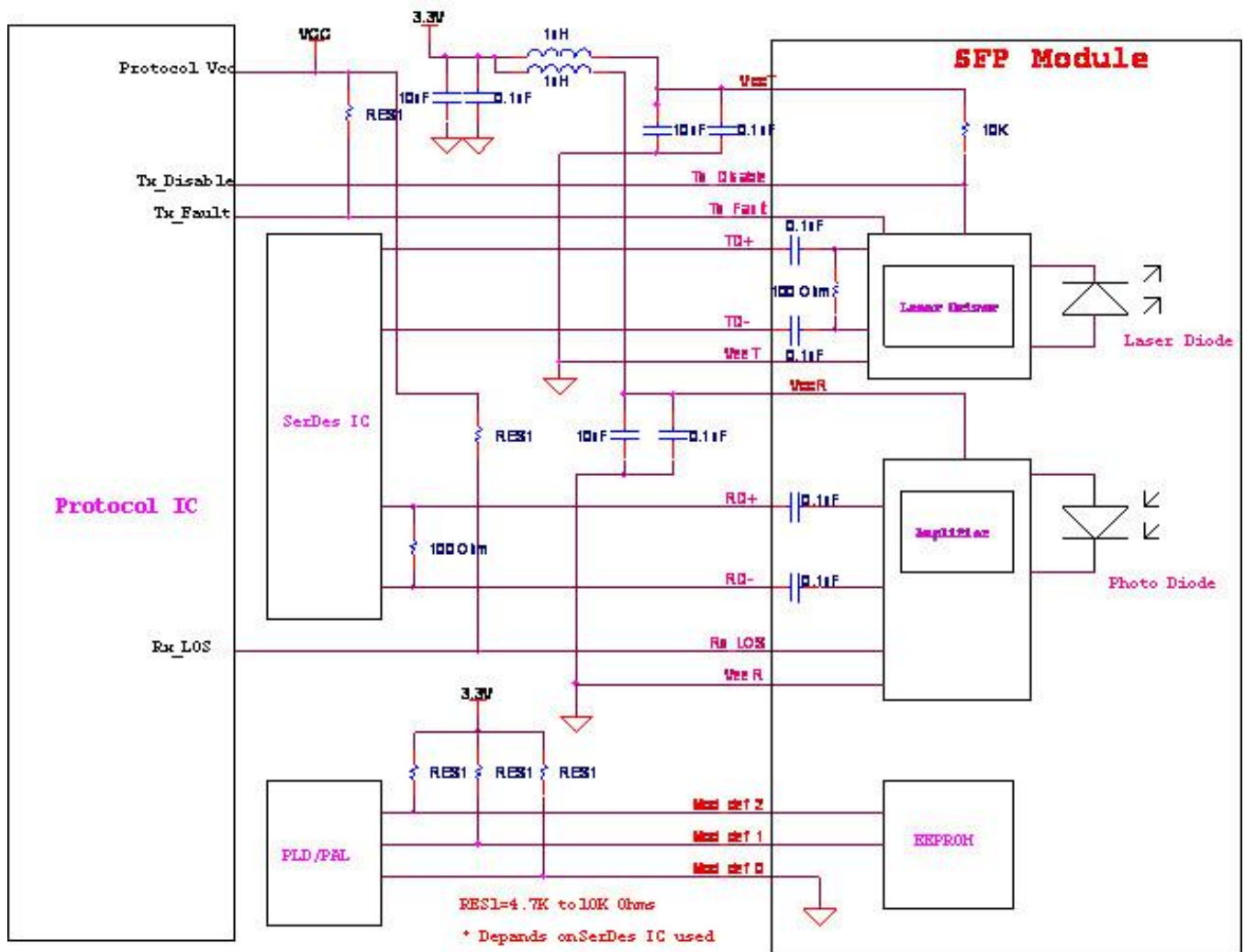

VIII. Mechanical Specifications (Unit: mm)

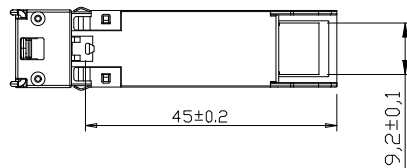
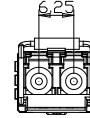
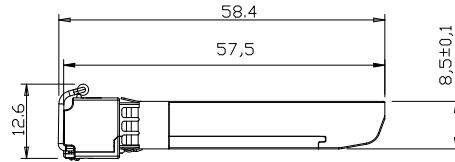
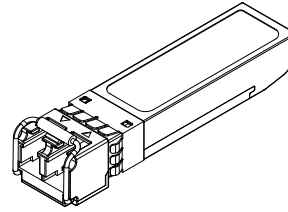
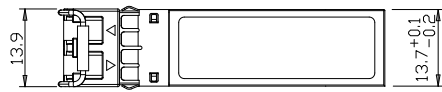

Units in mm

TS-SF-1315-02

IX. Regulatory Compliance

Feature	Reference	Performance
Electrostatic discharge (ESD)	IEC/EN 61000-4-2	Compatible with standards
Electromagnetic Interference (EMI)	FCC Part 15 Class B EN 55022 Class B (CISPR 22A)	Compatible with standards
Laser Eye Safety	FDA 21CFR 1040.10, 1040.11 IEC/EN 60825-1 , 2	Class 1 laser product
Component Recognition	IEC/EN 60950 , UL	Compatible with standards
ROHS	2002/95/EC	Compatible with standards
EMC	EN61000-3	Compatible with standards

Appendix A. Document Revision

Version No.	Date	Description
1.0	2011-04-20	Preliminary datasheet
2.0	2011-09-10	Update format and company's logo